

REVISIONS				
ZONE	LTR	DESCRIPTION	DATE	APPROVED

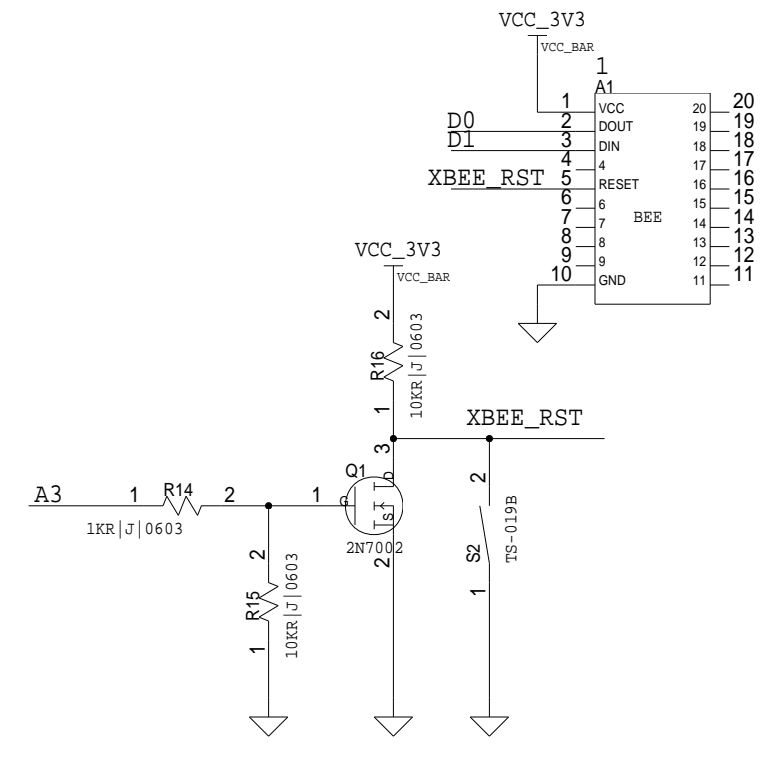
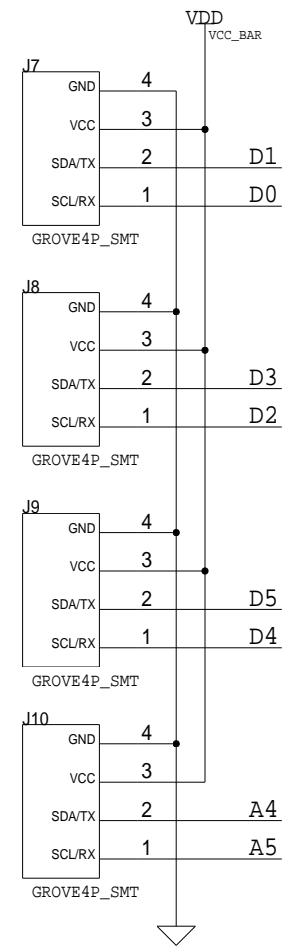
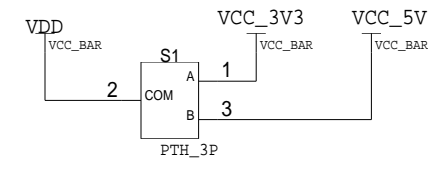
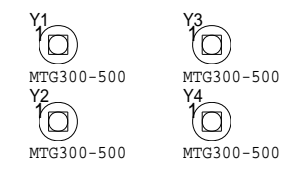
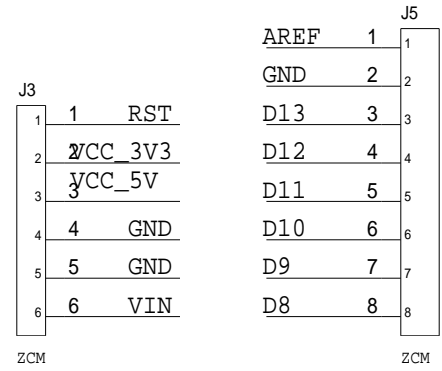
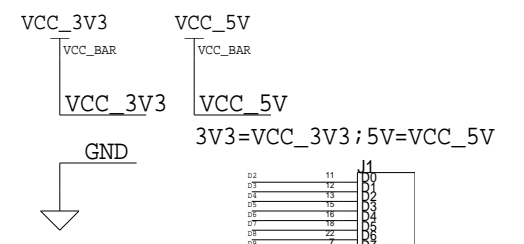

CONTRACT NO.			
APPROVALS	DATE		
DRAWN			
CHECKED			
		SIZE	DRAWING NO.
		B	
		SCALE	SHEET OF

ITEAD

REVISIONS				
ZONE	LTR	DESCRIPTION	DATE	APPROVED

N.C.=GND; VLSS=GND; VSS=GND; VBAT=VCC_3V3; VDD=VCC_3V3

OLED_2864

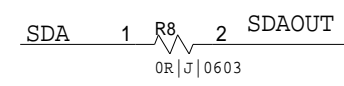
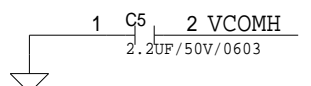
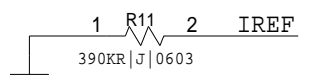
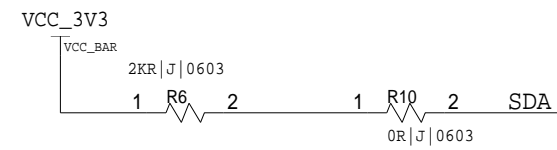
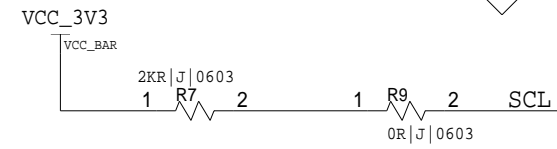
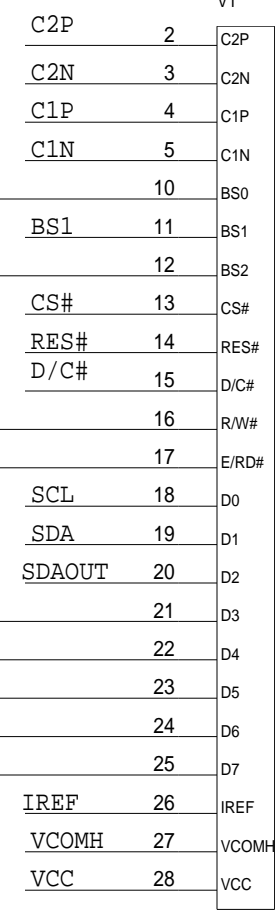
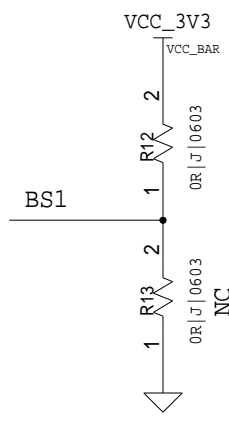
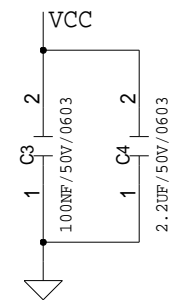
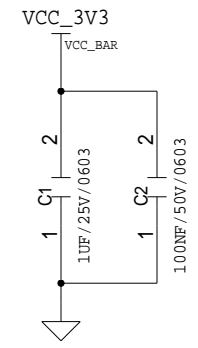
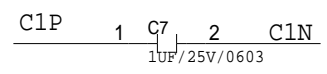
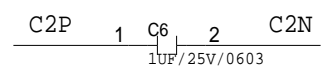
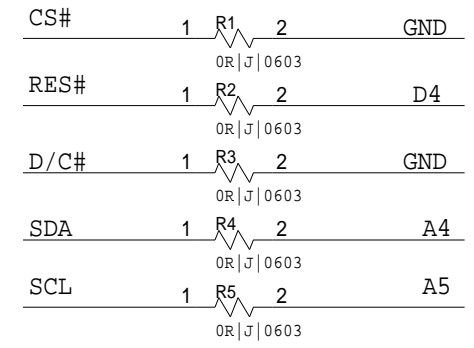

CONTRACT NO.			
APPROVALS	DATE		
DRAWN			
CHECKED			
		SIZE	DRAWING NO.
		B	
		SCALE	SHEET OF

ITEAD