

(RDBR)
redboard
breadboard

Redboard Breadboard Assembly Guide

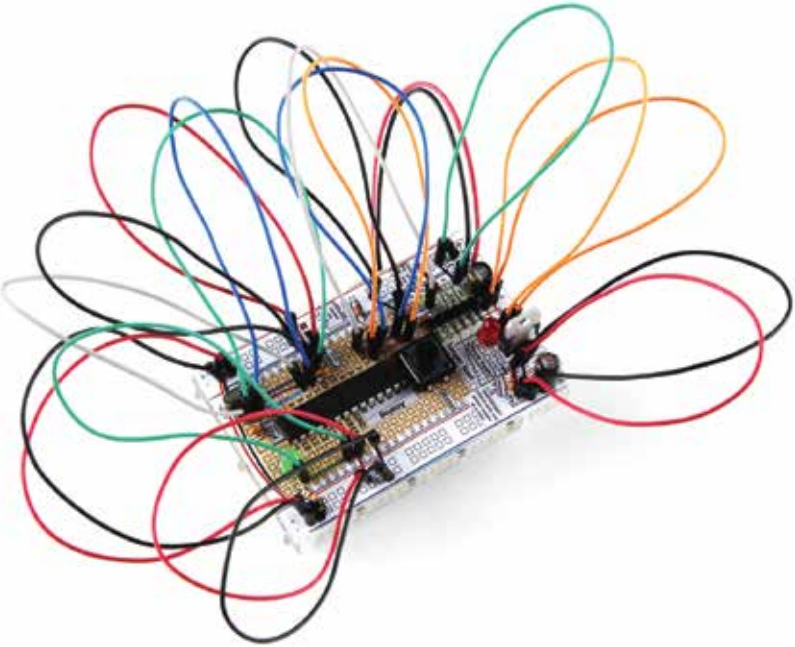

(RDBR)

sparkfun.com



A Few Words

ABOUT THIS KIT

The overall goal of this kit is fun. Beyond this, the aim is to get you comfortable using a wide range of electronic components through small, easy circuits. The focus is to get each circuit working then give you the tools to figure out why. If you encounter any problems, want to ask a question, or would like to know more about any part, extra help is only an e-mail away help@oomlout.com.



ABOUT OPEN SOURCE HARDWARE

All of the projects at SparkFun and [.oomlout.](http://www.oomlout.com) are open source. What does this mean? It means everything involved in making this kit, be it this guide, 3D models, or code, is available for free download. But it goes further, you're also free to reproduce and modify any of this material, then distribute it for yourself. The catch? Quite simple; it is released under a Creative Commons (By - Share Alike) license. This means you must credit [.oomlout.](http://www.oomlout.com) in your design and share your developments in a similar manner. Why? We grew up learning and playing with open source software and the experience was good fun, we think it would be lovely if a similar experience was possible with physical things.

More details on the Creative Commons CC (By - Share Alike) License can be found at <http://creativecommons.org/licenses/by-sa/4.0/>

ABOUT [.oomlout.](http://www.oomlout.com)

We're a plucky little design company focusing on producing
"delightfully fun open source products"

To check out what we are up to

<http://www.oomlout.com>

ABOUT SPARKFUN

SparkFun is an energetic young company seeking to make electronics fun, accessible, and approachable to everyone - from kids in elementary school to PhD-toting engineers.

<http://www.sparkfun.com/>

ABOUT PROBLEMS

We strive to deliver the highest level of quality in each and every thing we produce. If you ever find an ambiguous instruction, a missing piece, or would just like to ask a question, we'll try our best to help out.

help@oomlout.com

(we like hearing about problems it helps us improve future versions)

**Thanks For Choosing [.oomlout.](http://www.oomlout.com)
and SparkFun**

[.: Where to Find Everything .:](#)

TBCN
table of contents

{PART}	Required Parts	02
{COMP}	Comparing a RDBR to an Arduino USB	03
{SCHEM}	RDBR Schematic	04
{ASEM}	Assembly Instructions	05
{PROG}	Programming Instructions	08
{NOTE}	Room to Take Notes	09





01 PART

the parts



:: The Parts Needed for a :: :: Redboard Breadboard ::





Capacitors

-  **100 uf** - filters the power supply
-  **100 nf** - bypass capacitor (104)
-  **22 pf** - filters the crystal (220)

Resistors

-  **330 ohm** (orange-orange-brown)
LED current limiting
-  **10k ohm** (brown-black-orange)
Pull-ups

Headers

-  **6 Pin** - used for programming with an FTDI cable
-  **2 Pin** - used to pin down the breadboard layout sheet.

Breadboard

 Allows for easy assembly of circuits without soldering

Breadboard Layout Sheet

 Place on top of a breadboard to show where components go

Pushbutton - (Reset)

 Resets the micro-controller when pressed

Battery Clip - (9v)

 For powering the board with a 9v battery

Crystal - (16 MHz)

 Provides a clock signal for the ATmega chip

Microcontroller - (ATmega328)

 A single chip computer that runs your code

Voltage Regulator - (7805)

 Takes in 7-12 volts and outputs 5 volts

LEDs- (Light Emitting Diodes)

 Used as indicators
Red - power
Green - connected to pin 13

:: An Arduino Uno:: &

:: Redboard Breadboard Compared::

02 COMP

comparison

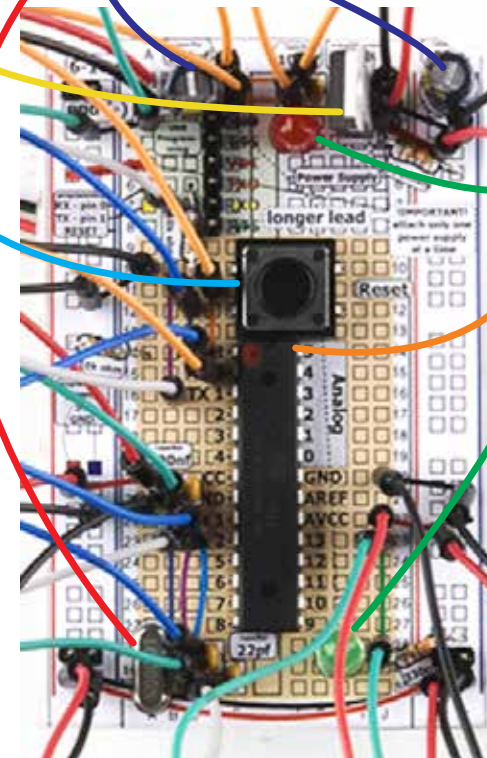

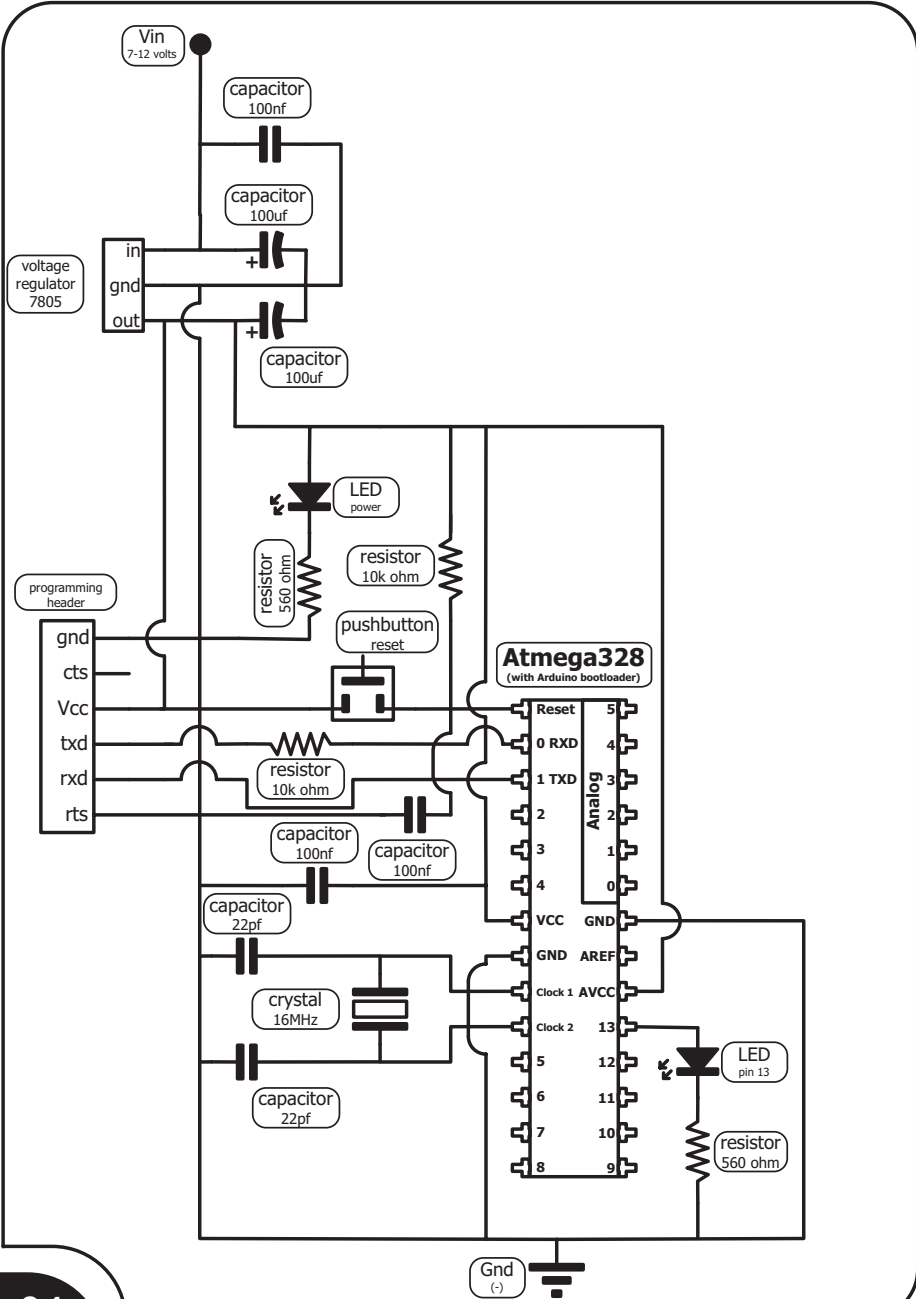

:: Redboard Breadboard ::
:: Schematic ::



:: Redboard Breadboard ::
:: Assembly Steps ::

Parts:

-  Breadboard x1
-  Breadboard Layout sheet x1
-  2 Pin Header x3

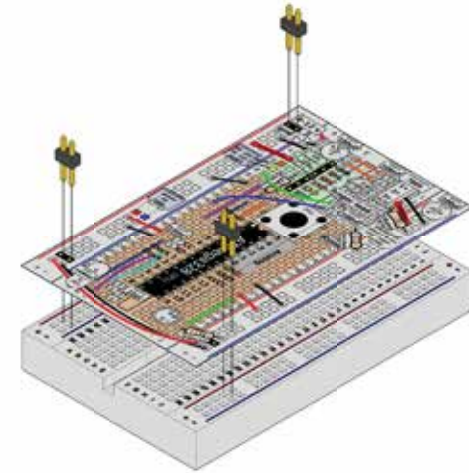

1

Parts:

-  wire
-  330 ohm resistor (orange-orange-brown) x2
-  10k ohm resistor (brown-black-orange) x2

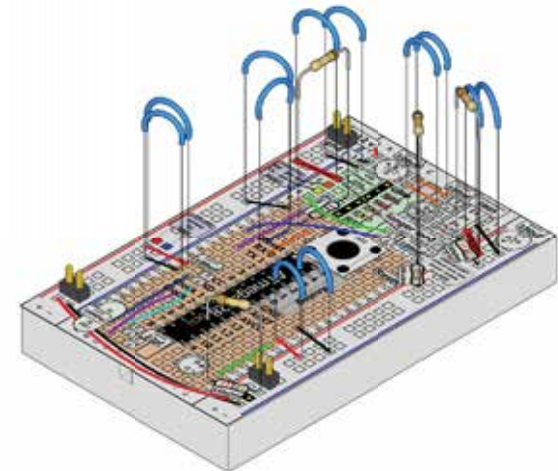

2

Parts:

- 
Capacitor
100 uf
x2
- 
Capacitor
100 nf (104)
x3
- 
Capacitor
22 pf (220)
x2

the smoothing capacitors will have 220 written on them

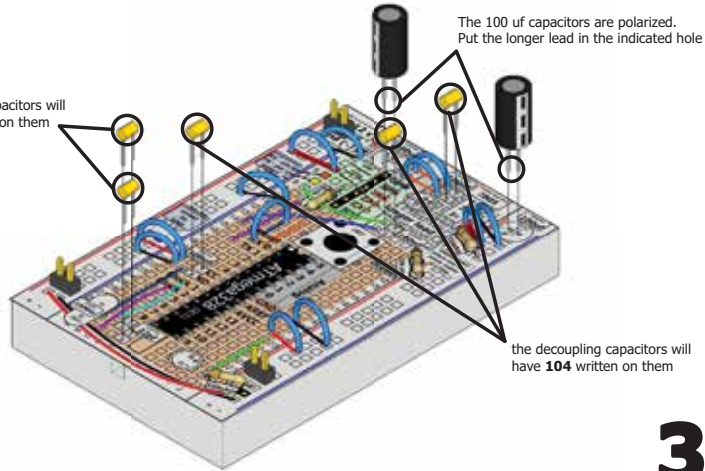

The 100 uf capacitors are polarized. Put the longer lead in the indicated hole

the decoupling capacitors will have 104 written on them

3

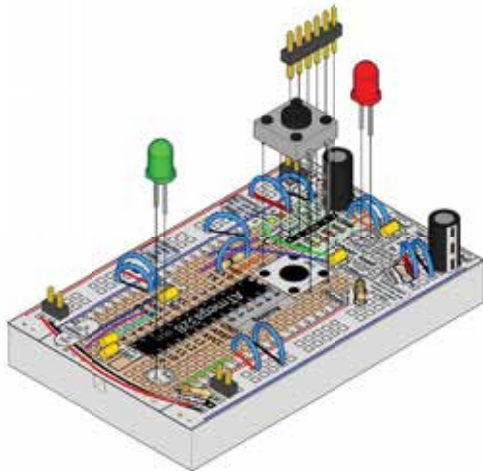

Parts:

- 
Pushbutton
x1
- 
Header (6 pin)
x1
- 
Red LED
x1
- 
Green LED
x1



4

Parts:

- 
Microcontroller
ATmega328
x1
- 
Crystal
(16 MHz)
x1
- 
Voltage Regulator
(7805)
x1

There is a half moon cutout, this goes at the top

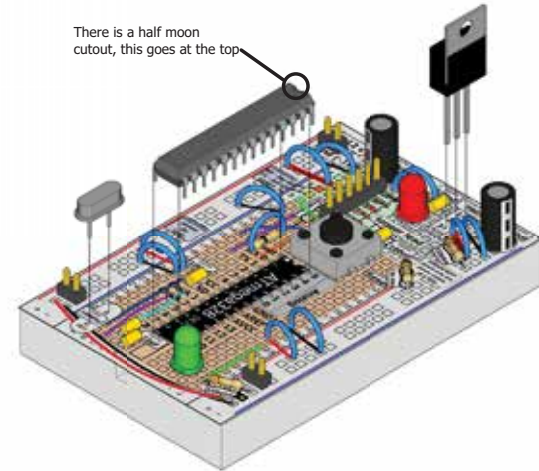

5

Parts:

- 
Wire
- 
Battery Clip
x1

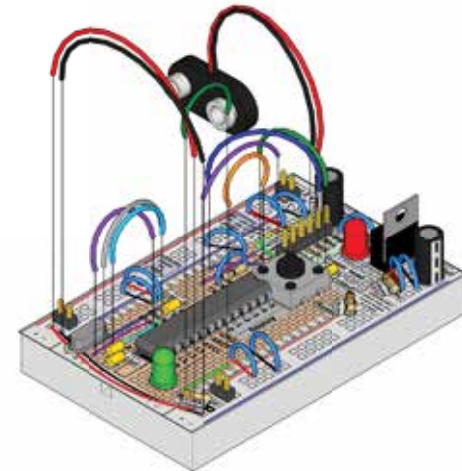

6

(RDBR)
redboard
breadboard

sparkfun.com



www.oomlout.com

This work is licenced under the Creative Commons Attribution-Share Alike 3.0 Unported License. To view a copy of this licence, visit <http://creativecommons.org/licenses/by-sa/3.0/> or send a letter to Creative Commons, 171 Second Street, Suite 300, San Francisco, California 94105, USA.